



AYO™ WX

AROUND-NECK PAPR SERIES



AYO WX FFM-LF
LOOSE-FITTING

AYO WX FFM-DS
DOUBLE-SEAL

AYO WX HFM
STANDARD

AYO WX HFM-SP
SPEECH-ENHANCED

AYO WX HFM-W
WELDING

USER MANUAL



CMI ProdCert

PC10112
AS/NZS 1716:2012

A NEW STANDARD IN PROTECTING WORKERS' LUNGS

CONTENTS

Foreword	3	Inspection and Maintenance	16
Introduction	3	Daily Inspection and Maintenance	16
Safety Warnings & Limitations	3	Flow Capacity Check Before Each Use	16
Know your AYO WX	4	Cleaning the Main Unit	17
System Overview	4	Cleaning the Mask Assembly	17
System Summary Table	5	Quarterly Maintenance	18
Mask Assembly	6	Deep cleaning	18
Power Unit	7	Storage	18
Filter Unit	9	Filter Replacement Instructions	19
Donning (Half-Face Mask Assembly)	10	Filter Unit Connection	19
Donning (Full-Face Mask Assembly)	11	Particulate Filter Replacement	20
FFM-DS (Double-Seal)	11	Gas Filter Replacement	22
FFM-LF (Loose-Fitting)	12	Battery Replacement Instructions	23
Doffing (Half-Face Mask Assembly)	13	Full-Face Mask Assembly and Disassembly Instructions	24
Doffing (Full-Face Mask Assembly)	13	Troubleshooting	26
Fit Check & Testing (HFM and FFM-DS)	14	Specifications	27
Fit Check (Self-Assessment)	14	Replacement/Consumables/Accessories	28
Fit Test	14	Disclaimer	28
Special Use Case.....	15	Limited Liability	28
Working with Beards.....	15	Warranty	28

Foreword

Before using the AYO WX Series Respirators, users must read and understand the User Manual. Keep these instructions for future use. Not following these instructions can harm your health or void the warranty.

Introduction

Congratulations on purchasing the AYO WX - the advanced around-neck breath-responsive powered air-purifying respirator. It is designed for use in general industrial dust or toxic environments where strong respiratory protection is needed. The AYO WX uses a smart control algorithm to keep positive air pressure in the mask with each breath. This ensures a high level of protection and comfort.

Safety Warnings & Limitations



Warnings and Limitations

- **Non-Oxygen Supplying:** The respirator does not supply oxygen. Do not use in low-oxygen environments.
- **Only Effective Against Specific Contaminants:** Dust, fumes, specific gases, and vapors. Always ensure the filters are suitable for the contaminants present.
- **Do Not Use in IDLH Environments:** Should not be used in Immediately Dangerous to Life or Health (IDLH) situations or environments with unknown contamination levels.
- **Ensure Proper Sealing and Fit of the Facepiece:** Improper mask size, facial hair, glasses, or other obstructions can reduce the respirator's protection.
- **Positive Pressure Limitation:** In high exertion work, the air pressure inside the mask may briefly go negative at early stage of inhalations, reducing its protection. In this situation, tight-fitting mask is recommended.
- **Not for Escape Use:** The AYO WX Series Respirators are not designed for emergency escape scenarios. It is meant for use in controlled environments.
- **Responding to Warning Signals:** Exit the contaminated area immediately if any alert systems activate (e.g., low battery, filter blockage) or if you feel unwell, have trouble breathing or increased breathing resistance, or any part of the system becomes damaged, or detect contaminants by smell or taste.
- **No Modification or Improper Use:** Do not replace, modify, add, or remove any parts of the respirator unless specified in the User Manual.



Safety Guidelines

- **Correct Use:** The user must carefully read this User Manual before first use, and understand and be familiar with its proper use, maintenance and limitations.
- **Health Considerations:** Individuals with respiratory conditions (e.g., asthma, emphysema) should consult a doctor and undergo a medical evaluation before using the device.
- **Air Supply:** If during use the air supply stops or is significantly reduced, vacate the contaminated area immediately and investigate the cause of the malfunction before resuming use.

- **Maintenance and Functionality:** Regularly inspect and clean the respirator, charge the battery, and replace the filter per guidelines in the **Inspection and Maintenance** section. Ensure the device has sufficient charge and flow capacity before each use.
- **Respirator Removal:** Do not remove the respirator until you have left the contaminated area.
- **Storage:** Store the AYO WX in a clean, dry and cool area when not in use.

Know Your AYO WX

System Overview

The AYO WX system comprises two major parts.

1. **Mask Assembly:** sits on the face and is secured by its head harness.
2. **Main Unit:** blows filtered air to the mask. Located around the neck, it contains 3 parts.

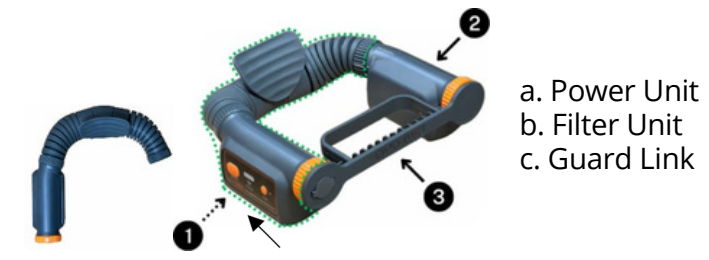

Power Unit: houses the electronics and battery, and facilitates the airflow.

Filter Unit: attaches to the Power Unit and filters the air.

Guard Link: protects the Main unit when not in use or during clearing. It also facilitates Flow Capacity Testing.

Below images show the available systems:



AYO WX HFM Standard
Half-Face Mask PAPR System



AYO WX HFM-SP Speech-Enhanced
Half-Face Mask PAPR System



AYO WX HFM-W Welding
Half-Face Mask PAPR System



AYO WX FFM-DS Double-Seal
Full-Face Mask PAPR System



AYO WX FFM-LF Loose-fitting
Full-Face Mask PAPR System

System Summary Table

System	Mask Assembly	Main Unit	
		Power Unit	Filter Unit
AYO WX HFM Standard Half-Face Mask PAPR System P-Standard	HFM Assembly (S/M/L)	Power Unit P-Standard	Particulate
AYO WX HFM Standard Half-Face Mask PAPR System P-Boost	HFM Assembly (S/M/L)	Power Unit P-Boost	Particulate
AYO WX HFM Standard Half-Face Mask PAPR System Gas	HFM Assembly (S/M/L)	Power Unit Gas	Gas
AYO WX HFM-SP Speech-Enhanced Half-Face Mask PAPR System P-Standard	HFM-SP Assembly (S/M/L)	Power Unit P-Standard	Particulate
AYO WX HFM-SP Speech-Enhanced Half-Face Mask PAPR System P-Boost	HFM-SP Assembly (S/M/L)	Power Unit P-Boost	Particulate
AYO WX HFM-SP Speech-Enhanced Half-Face Mask PAPR System Gas	HFM-SP Assembly (S/M/L)	Power Unit Gas	Gas
AYO WX HFM-W Welding Half-Face Mask PAPR System P-Standard	HFM-W Assembly (M/L)	Power Unit P-Standard	Particulate
AYO WX HFM-W Welding Half-Face Mask PAPR System P-Boost	HFM-W Assembly (M/L)	Power Unit P-Boost	Particulate
AYO WX HFM-W Welding Half-Face Mask PAPR System Gas	HFM-W Assembly (M/L)	Power Unit Gas	Gas
AYO WX FFM-LF Loose-Fitting PAPR System P-Standard	FFM-LF Assembly (ML)	Power Unit P-Standard	Particulate
AYO WX FFM-LF Loose-Fitting PAPR System P-Boost	FFM-LF Assembly (ML)	Power Unit P-Boost	Particulate
AYO WX FFM-LF Loose-Fitting PAPR System Gas	FFM-LF Assembly (ML)	Power Unit Gas	Gas
AYO WX FFM-DS Double-Seal PAPR System P-Standard	FFM-DS Assembly (ML)	Power Unit P-Standard	Particulate
AYO WX FFM-DS Double-Seal PAPR System P-Boost	FFM-DS Assembly (ML)	Power Unit P-Boost	Particulate
AYO WX FFM-DS Double-Seal PAPR System Gas	FFM-DS Assembly (ML)	Power Unit Gas	Gas

Table 1: AYO WX Series - System Configurations

- Refer to Product Brochures for more information or visit our website www.aimwellbreathing.com.

Mask Assembly

Available in different size options.



1. Exhalation Valve
2. Half-Face Mask – (Standard/SP/Welding)
3. Elastic Strap
4. Plastic Headband
5. Main Unit Resting Hook
6. Strap Connector
7. Push-Fit Plug

a) Half Face Mask Assembly

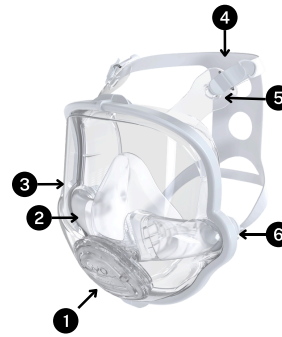

1. Front Module Assembly
2. Inner Mask Assembly (FFM-DS)
3. Lens & Cushion Assembly
4. Head Strap Assembly
5. Fit Adjust Toggles
6. Push-Fit Plug

b) Full Face Mask Assembly

note: WX FFM-LF does not include the Inner Mask Assembly.

Mask Size Guide

The table below outlines the size options for half and full-face masks, providing height measurements to help select your mask size.

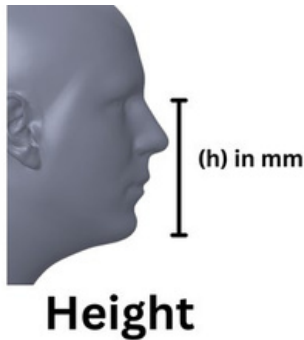

HFM		FFM-DS (Double-Seal)		FFM-LF (Loose-Fitting)
Mask Size	Height	Mask Size	Height	Height
Small	95-105	Medium-Large	110-140	95-140
Medium	105-120			
Large	120-135			

Note:

- User protection is compromised when tight-fitting Mask Assembly does not fit the user properly.
- Always perform the Fit Test assessment for better fit and protection for tight-fitting masks.
- For FFM-DS Assembly, the suitable range is determined by the same height on the face as is for the HFM.

- For complete information and video tutorials on Mask Size Options, visit our website www.aimwellbreathing.com.

Power Unit

There are 3 models which are designed for different use cases. All the variants have the same interface and differ in performance. Detailed information can be found in the **Operation Mode** section.



Figure 3: Power Unit



1. Power Unit P-Standard



2. Power Unit P-Boost



3. Power Unit Gas

User Interface



All Power Units have 3 LED Indicators, 2 buttons and 1 buzzer.

1. ON/OFF button
2. Battery Level Indicator LED(s)
3. Blocked Filter Indicator LED
4. Buzzer (installed inside the casing)
5. TEST/MODE button
6. TEST/MODE LED

1. ON/OFF button: performs different actions based on the state of the device.

- a. In **Sleep Mode**, press once to switch to **Standby Mode**.
- b. In **Standby Mode**, press once to start the Motor and enter the **Run-Eco Mode**.
- c. When the buzzer is active, press once to mute the buzzer.

2. Battery Level Indicator: These orange LEDs indicate the battery level. In addition, these LEDs will indicate the flow capacity while in **Flow Capacity Check Mode**.

Battery Level (%)	Number of LEDs ON
85 to 100	3
20 to 84	2
5 to 19	1
< 5	0

Table 2: Battery Level & LED State

3. **Blocked Filter Indicator:** The red LED will turn on if a filter block is detected.

4. **Buzzer:** In **Standby Mode**, pressing any buttons will trigger the buzzer briefly. It will also beep when the respirator detects a low battery or a blocked filter.

5. **TEST/MODE Button:**

- In **Standby Mode**, press once to start **Flow Capacity Check** (Guard Link must be connected) (Refer to **Maintenance** section for instructions)
- In Particulate Boost Power Unit, when the system is in **Run-Eco Mode**, press and hold for 2 seconds to switch into **Run-Boost Mode** and vice-versa

6. **TEST/MODE LED:** The LED has different states based on the Operation Mode. Refer to Table 4.

Buzzer State	Beeps per Second
Low Battery	3
Blocked Filter	2

Table 3: Buzzer Function

Operation Mode	LED State
Eco	OFF
Boost	Blink (□ 50% duty cycle)
Flow Capacity Check	ON

Table 4: TEST/MODE LED States

Operation Mode

Standby Mode

Sleep Mode

Run Mode - Eco

Run Mode - Boost

1. Standby Mode: The motor is stopped while the system is actively monitoring for user inputs or breathing action.

- Test and Blocked Filter LED's will be OFF and Battery Level Indicator will be ON.
- When breath is detected or ON/OFF button is pressed, the system will switch to Run-Eco Mode (by default).
- If the system detects 10 minutes of inactivity, it will switch to Sleep Mode.

2. Sleep Mode: The system is placed into a low-power state, to reduce battery consumption. By pressing the ON/OFF button, the system will switch to Standby Mode.

3. Run Mode - Eco: it is designed to maintain positive pressure in the mask with lower power consumption. Ideal for low to moderate intensity work or requiring long operation time. When the mask is taken off, the system will switch to Standby Mode automatically.

4. Run Mode - Boost (Particulate Boost Power Unit Only): ideal for high-exertion work with heavy breathing, where about twice as much air volume will be generated compared with the Eco mode.

Charging The Battery

The charging port of the battery is located on the bottom right corner of Power Unit Case.

Open the soft Charging Port Cover before charging. Plug in the power adapter to charge. Close the Charging Port Cover when finished.

Charging indication:

- One light will flash during charging, and the other two lights are either always on or off depending on the charging status.
- When the battery is charged to about 95% of its capacity, the flashing frequency increases significantly.
- When the battery is fully charged, all three lights are always on.
- It takes 30 minutes to charge from 95% to 100%. Usually, you can assume that the battery is fully charged when the indicator light flashes quickly.

Charging Conditions: 0°C to 35°C in a dry and protected space.

Battery Charging Door

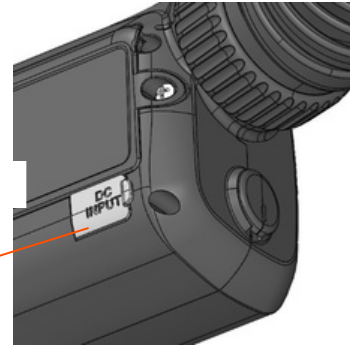

Filter Unit

Filter unit and power unit are detachably connected. There are 2 variants: Particulate and Gas. The Particulate Filter Unit contains a pre-filter and a main filter, while the Gas Filter Unit contains a HEPA filter and a gas cartridge.

To learn more about filter options for AYO WX Series Respirators, visit our website at www.aimwellbreathing.com.



a) Particulate Filter Unit



b) Gas Filter Unit

Refer to **Filter Unit** in **Assembly/Disassembly Instructions** section for filter change requirements.

Donning (Half-Face Mask Assembly)

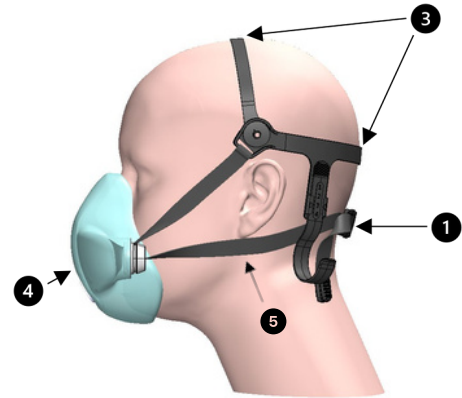
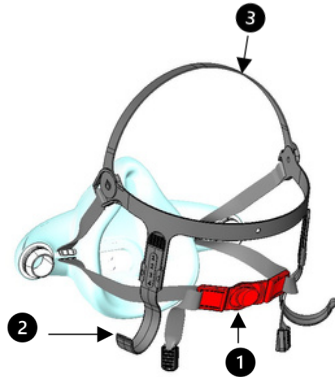

1. Connect strap connectors (1) (a hook and a loop) to each other. Insert the support hooks (2) into slots on the head strap (3) (The left hook and the right hook are identical).

2. Pull the connected lower part of the strap (5) containing the Strap Connector (1) on the back of your neck and put the Silicone Mask (4) on your face. Then Slide the Plastic Headbands (3) to the top and back of the head. Adjust the Mask fit by pulling the straps through the strap connector (1).



3. Remove Guard Link from Main Unit



4. Press the "ON/OFF" Button to switch the system to Standby Mode, ensure minimum 2 battery LEDs are ON. Otherwise, charge the unit.



5. Use two hands to hold the two sides of the Main Unit.

6. Slide the Main Unit down against the back of the head until the Rubber Bellows (5) come to rest in the Hooks (4).

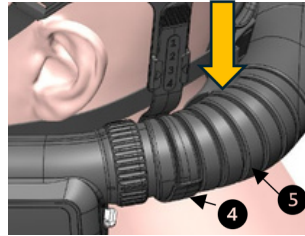

7. Push each end of the main unit to the corresponding plug of the mask until you hear a click sound, ensuring the connection is secure and cannot be pulled apart.

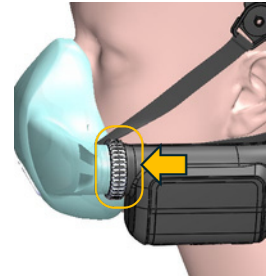

8. Adjust the height the hook (6) along the slot (7) of the Plastic Strap to ensure the Main Unit is off and parallel to the shoulder for best mobility.

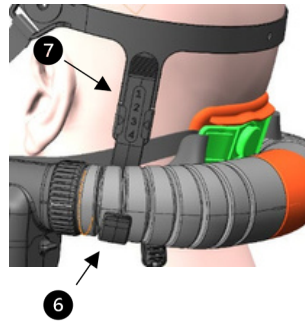

9. Place the strap Connectors (8) on the neck pad (9) of Main Unit to better support Main Unit

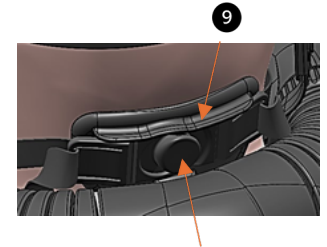

Donning (Full-Face Mask Assembly)

FFM-DS (Double-Seal)



1. When putting on the FFM-DS for the first time, fully loosen all headgear toggles. Place your head into the FFM Assembly through the lower opening of the head straps, if necessary, pull hair back out of the mask area.
2. Place your bottom chin on top of the bottom cushion and the front of your chin in close contact with the inner mask cushion. Then, push the FFM cushion evenly against your face, ensuring the inner mask cushion contacts and presses against your nose bridge.
3. While holding the FFM, pull each strap evenly for a secure fit.

Note: Ensure no hair is under the mask cushion, and the straps are tightened sufficiently. Bend over and check if you feel any leaks or loose points between your face and the mask cushions.

If so, further tighten the strap closer to the leak or loose point until the mask fits snugly and securely on your face.

4. Hold on the base of one push-fit plug of the Mask with one hand while tilting it outward slight, push the corresponding end of Main Unit onto the push-fit plug until a click sound is heard, making sure the connection is secure and can not be pulled apart. Repeat the connection on the other end.



Note: Align the Main Unit with the push-fit plug axially for a smooth connection.

5. Pull the strap band out while pulling the neck pad on the Main Unit into the opening, and ensure the band is latched on the neck pad.



Adjust the four straps to ensure the main unit sits parallel to and clear from the shoulder.

To **raise the main unit**, tighten the top two straps and loosen the bottom two.
 To **lower the main unit**, loosen the top two straps and tighten the bottom two.

FFM-LF (Loose-Fitting)

Fitting of the Loose-Fitting Full-Face Mask (FFM-LF) is similar to FFM-DS, except placing the front of your chin in contact with the Chin Support shown below:

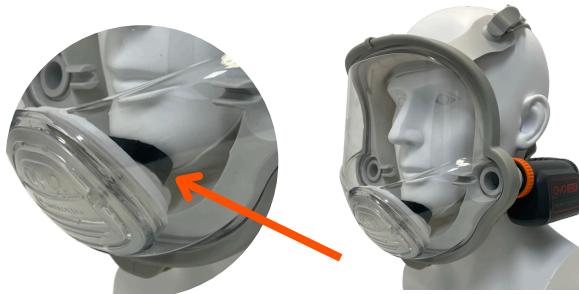

Doffing (Half-Face Mask Assembly)

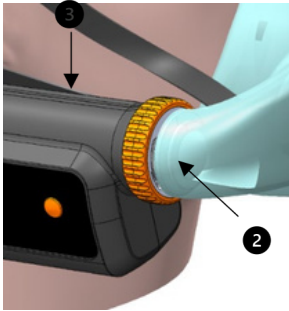

1. Disconnect the Main Unit from the Mask Assembly by twisting the grip ring of the Twist-release socket (2) while holding the Filter Unit / Power Unit (3).

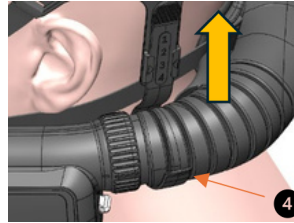

2. Remove the strap Connectors off the neck pad, then slide the Main Unit upwards against the neck to separate it from the Hooks (4) then take it off the head.



3. Fit the Guard Link back to the Main Unit.

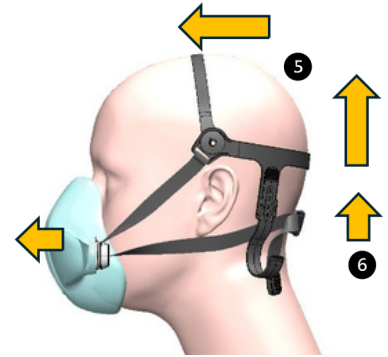

4. Pull Plastic Straps (5) off from the top and the back of the head.

5. Take Strap Connectors (6) off from the neck.

Note: Keep Hooks adjustment for the convenience of future use.

Doffing (Full-Face Mask Assembly)

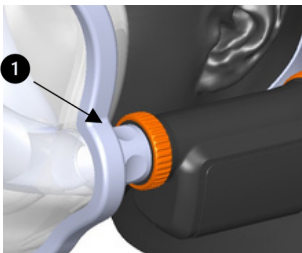

1. Disconnect the Main Unit from the FFM assembly by twisting the grip ring of the Twist release socket (1)



2. Lift the Main Unit up along the back of the head and take off the Main Unit.

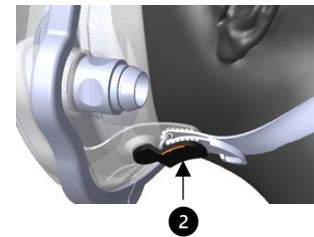

3. Loosen the bottom mask toggle (2) and remove the FFM assembly from the head.

Note: Keep the top 2 strap adjustment for the convenience of future use.

Fit Check & Testing (HFM and FFM-DS)

Fit Check (Self-Assessment)

1. Don the Mask Assembly (do not attach the Main Unit).
2. Using your Thumb (☞), block the two ends of the Mask Assembly's Push-Fit Mask Plug opening.



Half Face Mask Assembly



Full Face Mask Assembly

3. Inhale deeply. If the face cushion collapses slightly, the mask is roughly fit. If a leak flow is felt, firstly adjust strap tension and/or mask position on the face to see if the leaks are stopped.

If not, try a different mask size and repeat the check until the leak stops.

Fit Test:

To achieve the best protection from a tight-fitting AYO WX mask, we recommend conducting a Fit Test for the first time and then every 12 months using specialized Fit Testing equipment, such as the 'PortaCount Respirator Fit Tester 4048.' This Fit Test can be provided by suitable third-party services.

To connect to the external Fit Test system, use the special Fit Test Adaptor available as an accessory as shown below:



Method:

- Connect the Fit Test Adaptor between the air inlet of the mask and the air outlet of the Main Unit.
- Insert the sampling tube (2) through the mask air inlet to reach the middle of the mask.
- Connect the Fit Test Equipment sampling tube to the sampling port (1).

For more information, visit: <https://stage.aimwellbreathing.com/ayo-wx-quick-guides/>

Special Use Case

Working with Beards



Although being clean-shaven is recommended for achieving the highest protection that requires tight fitting of the respirator, AYO WX provides loose-fitting options for bearded workers and organizations that don't plan to perform fit testing for every worker.

AYO WX FFM-LF is the full-face mask system designed for bearded workers without fit testing, where a FFM Loose-Fitting Kit is provided as an option to cover beards from accumulating dust.



In addition, all AYO WX half-face masks can be fitted with the HFM Loose-Fitting Face Seal as an add-on accessory and used for bearded workers without fit testing too.

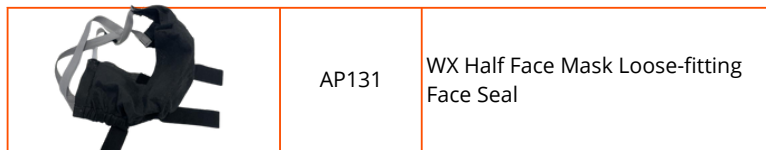

These loose-fitting options can still provide effective protection for most users with **normal beards under light to moderate workloads**. Thanks to its breath-responsive flow control technology, the AYO WX can adjust airflow to compensate for beard leaks, maintaining positive pressure in the mask.

Refer to: For more information, visit: <https://stage.aimwellbreathing.com/ayo-wx-quick-guides/> for fitting information.

Due to variations in beard thickness and length, it is important to check if your beard is too long which may cause excessive leaks before use. If you don't feel excessive leaks and the respirator works normally for a few minutes, it is an indication that your beard is acceptable.

Note:

- Do not use the PAPR if it stops due to excessive leaks. Trim your beard before using it again.
- Do not use the PAPR for strenuous work that requires heavy breathing.
- Beard leaks will consume more battery power, so keep your beard as short as possible and fully charge the battery before use.
- Avoid using blocked filters – change filters frequently.

Inspection and Maintenance

Daily Inspection and Maintenance

Visually check the following before each use:

- If the Bayonet connection between Filter Unit and Power Unit is correct.
- If the filter looks dirty or damaged.
- If Filter Door is correctly locked.
- If the bellows are damaged or torn.
- If the Grip Ring is free to return.

Flow Capacity Check Before Each Use

1. Make sure the Guard Link is fitted to the Main Unit (the flow plug end is at the air outlet)



2. Open the flow plug on the Guard Link.
3. In Standby Mode, press the TEST/MODE Button to run the Flow Capacity test.
4. The Batter LEDs will be shift-flashing before staying steady for 3 seconds, showing the Flow Capacity.
5. If the battery is fully charged and a new filter is fitted, 3 LEDs should be on, indicating a full Flow Capacity.
6. It is recommended to have a minimum 2 LEDs before using the respirator. Otherwise, charge the battery or change the filter.
7. After 3 seconds, it will resume Standby Mode, now close the plug on the Guard Link.

No. of LEDs ON	Flow Capacity	Suitability
3	High	Yes, highly recommended
2	Medium	Yes, recommended
1	Low	Yes, meet the manufacturer's minimum design flow rate
0	Extremely Low	No



Low-flow capacity may result in a compromised protection level.

Daily Cleaning: Clean Mask Assembly and Main Unit separately after each use.

After detaching Mask Assembly from Main Unit always attach the Guard Link to Main Unit.

Cleaning the Main Unit

Dry Cleaning

Use either a damp cloth or tissue to wipe the casing parts of the Main Unit, and clean the Grip Ring of the Twist-Release Socket as follows:

1. Wipe out any dust and grime buildup from the grooves.
2. Twist the grip ring in the direction of the arrow. Upon release, it should return to its original position smoothly without catching or getting stuck. If the action is not smooth, repeat a few times to clear any obstruction.

Tap Water Cleaning the Bellow Section

1. Connect the Guard Link to the Main Unit firmly and ensure the flow plug is fully closed.
2. Hold the Guard Link and use tap water to flush wash the bellow section of the Main Unit only.
3. Wipe-dry with a clean cloth.

Note:

Do not flush-wash the casing. (Water should not cross the yellow line.)



Cleaning the Mask Assembly

1. Use a damp cloth to wipe clean the mask inside and out.
2. If the mask is very dirty, use tap water to flush the inside and outside of the Mask, Drain and wipe off water from the Mask, then use a clean and dry cloth to rub dry each part of the Mask
3. Push-Fit Plug: Apply a thin layer of 100% silicone-based lubricant or Vaseline to the groove of the plug for smoother connection.
4. Leave the Mask in a clean and open space to dry further.

Quarterly Maintenance

Deep cleaning

- For FFM-DS , remove the Inner Mask.
- Soak the Mask including the Head Strap in soapy water or a suitable detergent such as mild dishwashing liquid or laundry liquid for 10 minutes.
- Rinse with clean water then repeat the above daily mask cleaning procedure.

Storage

- When not in use for a long period, store the AYO WX and its filters in the provided bag or a suitable container. Protect them from direct sunlight, dust, extreme temperatures, excessive moisture, and harsh chemicals.
- Charge the battery every 3 months when not in use for extended periods.
- Provided they are stored at room temperature, away from direct sunlight and high humidity, the shelf life from the year of manufacture for unused particulate filters is a maximum of 5 years, and for unopened gas cartridges is between 3 - 5 years. Refer to the label on the filter/cartridge for the expiry date.
- Once opened and even if not used, discard the gas cartridge within 6 months.

Filter Replacement Instructions

Filter Unit Connection

Follow the instructions below to attach/detach the filter unit from the power unit.



Position 1:
 "PUSH/PULL" on Filter Unit aligned with the marking on the Power Unit.



Position 2:
 "PUSH/PULL" on Filter Unit aligned with the marking on the Power Unit.

Detach Filter Unit from Power Unit:

- From Position 2, hold the Rubber Bellow grip of the Power Unit and twist the Filter Unit anti-clockwise until Position 1 is reached.
- Pull out to detach the Filter Unit.



Attach Filter Unit to Power Unit:

- Hold the Rubber Bellow grip of the Power Unit then align and push in the Filter Unit as in Position 1.
- Twist the Filter Unit clockwise until Position 2 is reached.



Particulate Filter Replacement

Filter Unit Structure:



1. Filter Door
2. Pre-Filter
3. Pre-Filter Rubber Adaptor
4. Main Filter
5. Filter Case

When to Change

- When the Pre-Filter or the Main Filter is visually dirty or oily, or
- When the Filter Blocked alarm is activated, or
- When the Main Filter has been used for more than 3 months for Standard Filter and 6 months for the Long Life Filter.

Note: Filter performance is affected by isopropyl alcohol (IPA), replace the affected filter immediately.

Replacing Pre-Filter:

1. Detach the Filter Unit from Power Unit.



2. Twist the Knob to unlock (🔓) position



3. Push the grips to slide the Door out.



4. While holding down the rubber place holder, pull out the Pre-Filter using the tab.

5. Replace it with a new Pre-Filter and slide the Filter Door back. Make sure the Knob is twisted back to lock (🔒) position.

6. Attach the Filter Unit to Power Unit.

Replacing Main Filter:

The first 3 steps are the same as above.

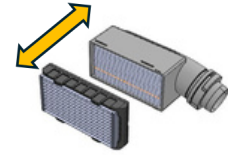

4. While holding the Inner Case and the rubber adaptor, pull open the outer case.

5. Remove the Pre-Filter & Main Filter (4) from the Filter Case.

6. Separate the Pre-Filter Assembly and dispose the Main Filter.

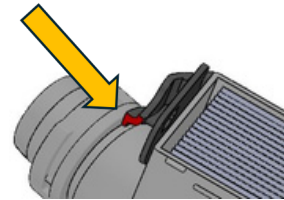
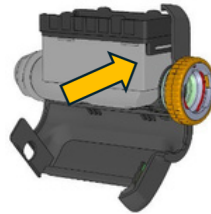
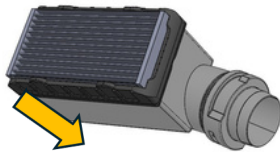

7. Attach Pre-Filter Assembly to the New Main Filter.

8. Place the combined filters back in the Inner Case.

! 9. Make sure the Inner Case edge aligns with the groove of the Filter.



10. Close the Outer Case back.

11. Press the 2 halve cases together with a 'click'.

12. Slide the filter door back on and lock the door.

13. Attach the Filter Unit to the Power Unit.

Gas Filter Replacement

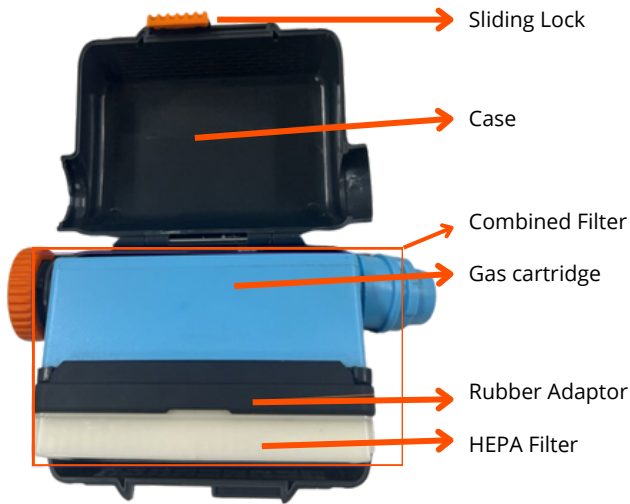

When to Change

- When HEPA Filter is visually dirty or oily, or
- When you can smell gases, or
- When the Filter Blocked alarm is activated, or
- When either filter has been used for more than 6 months.

Note: Filter performance is affected by isopropyl alcohol (IPA), replace the affected filter immediately.

Replacing HEPA Filter:

1. After detaching the Filter Unit from Power Unit, slide the Sliding Lock to unlock and open the Gas Filter Unit.
2. Take out the combined filter, remove the old HEPA filter and replace it with a new one following the arrow.



Replacing Gas Cartridge:

1. After taking out the combined filter, remove the old cartridge and replace it with a new one as shown in the image →
2. Fit the combined filter back to the case, close the case and return the Sliding Lock to the lock position.
3. Attach the Gas Filter Unit to the Power Unit.



Battery Replacement

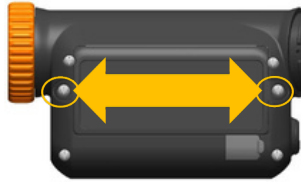

1. Using a S1.5 Allen key to remove the battery cover screws.

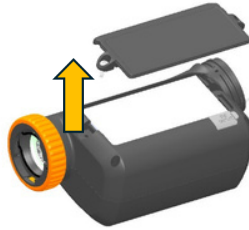

2. Remove the Battery Cover

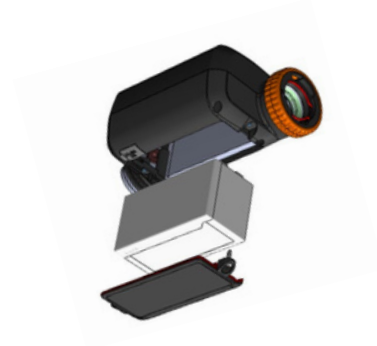

3. Face the battery door opening downward to remove the battery.



4. Fit new Battery as shown for the correct orientation.

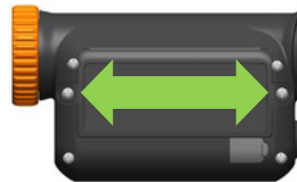

5. Install the Battery Door and tighten the two screws.

Full-Face Mask Assembly and Disassembly Instructions

Structure

1. Front Module Assembly
 - a. Screws
 - b. Front Module Cover
 - c. Exhalation Membrane
 - d. Speech Diaphragm
 - e. Common Membrane Seat
2. Lens/Cushion Assembly
3. Inner Mask Assembly
4. Push-Fit Plugs
5. Silicone Head Strap

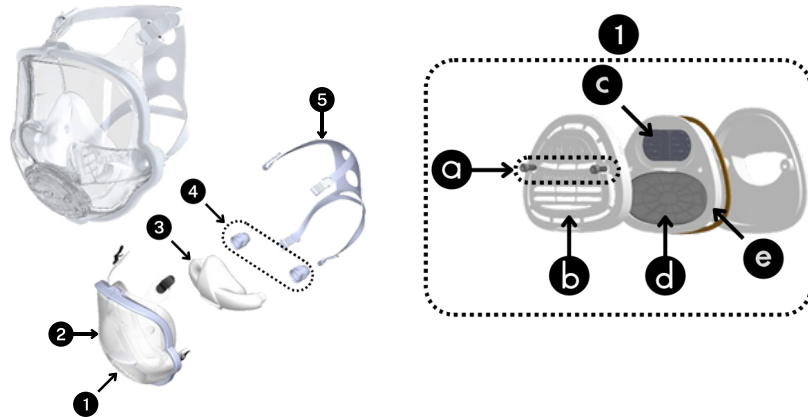

Disassembly Instructions:

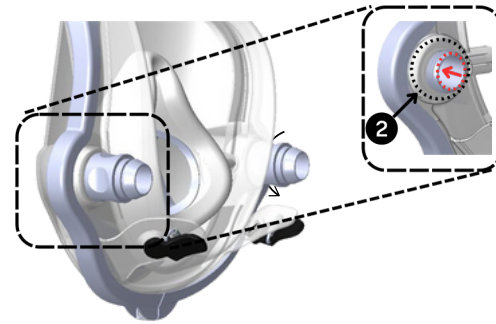

1. Take off the Front Module Cover (1b) by undoing the two screws (1a) using an Allen Key. The Cover will drop out by its weight when tilted. Remove the Common Membrane Seat using the pull tab.

2. Unscrew the push-fit adaptor. Once detached, push the threaded connector in through the hole (2). Repeat on the other side.



While handling the Common Membrane Seat, be careful not to damage the Exhalation Membrane & the Speech Diaphragm.

3. Remove the Inner Mask Assembly. When removed from the Lens/Cushion Assembly, the inner mask should look like the image on the right.

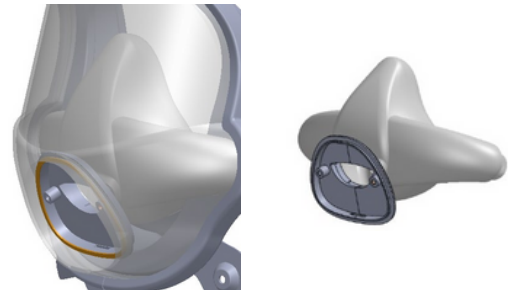

Assembly Instructions:

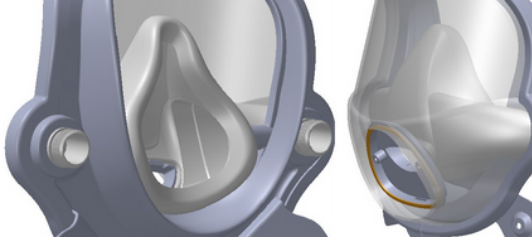

1. Fit the Inner Mask Assembly into the Lens/Cushion Assembly and push each thread connector through the hole on each side. Roughly align the Front Module Base of the Inner Mask Assembly to the Lens/Cushion Assembly's opening.

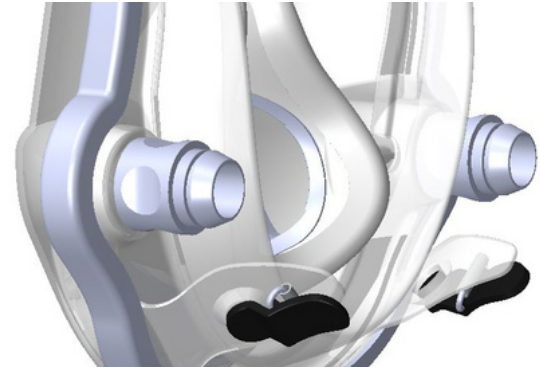

2. Screw the push-fit adaptor onto the inner mask threaded connector.



Do not over-tighten. Apply only finger-tight pressure.



3. Insert the Common Membrane Seat.

- Be careful not to clip or bend the silicone seal.
- Be careful not to damage the Exhalation Membrane & Speech Diaphragm.



4. Attach the Front Module Cover and screw on the two screws.



Do not over-tighten. Apply only finger-tight pressure.

Troubleshooting

Symptom	Possible Causes	Solution
Push-fit plug comes off or loose even after a hard push	The Grip Ring is stuck, or the Push-fit plug slot is dirty.	Rotate the ring a few times. Clean the slot on the Push-fit Plug, then smear a thin layer of Silicone- based lubricant.
Low flow or during flow capacity check, no or only one battery LEDs is on.	Foreign objects block the filter unit air inlet.	Remove the blocking objects .
	Pre-Filter blocked.	Replace the Pre-Filter with a new one.
	Main Filter blocked.	Replace the Main Filter with a new one.
The Filter-Blocked LED is lit and the buzzer beeps.	Low battery level.	Charge the battery to ensure 3 Battery Indication LEDs are lit.
	Foreign objects block the filter unit air inlet.	Remove the blocking objects.
	Pre-Filter blocked.	Replace the Pre-Filter with a new one.
Battery LEDs flash when the charger is connected and go off when the charger is removed.	Main Filter blocked.	Replace the Main Filter with a new one.
	Battery failure.	Replace the battery
Battery LEDs flash at Wake-up for around 10 seconds then become normal.	Low battery capacity.	Replace the battery

Specification

<p>Compliance</p>  <p>CMI ProdCert PC10112 AS/NZS 1716:2012</p>	Respiratory Protection	AS/NZS 1716:2012 PAPR-P3 (P3 filter filtration efficiency)
	EMC	<ul style="list-style-type: none"> • CISPR 11: 2017+A1:2020 • EN IEC 61326-1:2021 • EN IEC 61326-2-2:2021 • EN IEC 61000-3-2:2019/A1:2021 • EN 61000-3-3:2013/A2:2021 • 47 CFR FCC part 15, Subpart B • ANSI C63.4:2014
	Safety	AS/NZS 61558, EN 61558, UL 62368
	CMI Certification	AS/NZS 1716:2012 Lic: PC10112
Operation Conditions	Altitude	-1000m to 1000m
	Temperature	-10°C to 45°C (14°F to 113°F)
	Humidity	Up to 95% (non-condensing)
Battery Run Time	Particulate	Typically, 8 - 16 hours depending on the actual workload and dust concentration.
Peak Flow	Particulate	Over 200 l/min
	Gas	Over 160 l/min
Manufacturer Minimum Flow Condition	Particulate	120 l/min
	Gas	95 l/min
Weight (Power Unit)		430g
AC Charge Adaptor	Input	100 ~ 240VAC, 47~60 Hz
	Output	13.8VDC, 1A
	DC Jack plug	1.1mm pin, 3.0mm barrel
Battery Charging Conditions	Charge Temperature	0°C - 35°C
	Charge Time	3.5 hours = 95% charge 4.0 hours = 100% charge

Replacement/Consumable Items



Scan the QR code to shop for replacement

Disclaimer

You acknowledge and agree that at all times you will use AYO WX in accordance with any user documentation, instruction manuals, guides, and/or requirements we provide to you.

Aimwell makes no representations or warranties and shall not be responsible for the competency of any person who uses AYO WX. If you do not feel well using the AYO WX or have difficulty in breathing, please stop using the AYO WX.

Limited Liability

To the extent permitted by law, you will not hold Aimwell liable for any personal injury, loss of use, loss of profit, interruption of business, or any indirect, special, incidental, punitive, or consequential damages of any kind (including lost profits), regardless of the form of action, whether in contract, tort (including negligence), strict product liability, or otherwise, even if Aimwell has been advised or should have been aware of the possibility of such damages. To the extent permitted by law, Aimwell's liability to you for any claim, whether in contract, tort, or any other theory of liability, does not exceed the purchase price of the system paid by you.

It is further understood that Aimwell shall also have no liability whatsoever concerning damages arising out of or relating to unauthorized access, use, and/or alteration or destruction, by any third party, including any users, of the system or any data contained thereon or created by the system or your computer system.

Warranty

The warranty is valid for 12 months from the date of purchase, during which we offer repair or replacement of faulty products free of charge.

Contact:

info@aimwellbreathing.com
(02) 7251 8689